

# DEVELOPING ROBUST AND ECONOMICAL SOLUTIONS FOR BUILDINGS SUBJECT TO BUSHFIRE ATTACK

Ken Watson<sup>1</sup>, Michael Kelly<sup>2</sup>, Ian Bennetts<sup>3</sup> & Justin Leonard<sup>4</sup>

**ABSTRACT:** *The Black Saturday Bushfires in Victoria in 2009 caused great personal loss and property damage including the deaths of 173 people and the destruction of over 2,000 houses. Non-combustible construction offered some benefits as the building could be configured so that failure of one element did not lead to failure of the structure. These concepts were fire tested by CSIRO using a full size building complemented by smaller scale testing of elements using a thermal action curve which conservatively modelled a real bushfire.*

*Following the successful development of a system which provided a robust, economical solution, the challenge was to develop tools to assist in the design and construction of buildings. It was decided that the development of a standard was the best method to allow the information be transferred to practitioners.*

*The paper reviews the performance requirements of the National Construction Code. It also explains where fire engineering is combined with experimental results to develop solutions for different levels of bushfire exposure.*

*A case study of a housing development in Brisbane is presented. The principles of the new standard were applied as an Alternative Solution to improve the bushfire resistance and reduce the constructed cost of a 76 townhouse project. The standard delivers robust, economical solutions for buildings constructed in bushfire areas.*

**KEYWORDS:** Bushfire, wildfire, fire, steel framing, housing, non-combustible, standard, regulations

---

<sup>1</sup> Ken Watson, National Association of Steel-Framed Housing Inc. Email: [kwatson@nash.asn.au](mailto:kwatson@nash.asn.au)

<sup>2</sup> Michael Kelly, National Association of Steel-Framed Housing Inc. Email: [mkelly@nash.asn.au](mailto:mkelly@nash.asn.au)

<sup>3</sup> Ian Bennetts, Noel Arnold & Associates Pty Ltd. Email: [ian.bettetts@noel-arnold.com.au](mailto:ian.bettetts@noel-arnold.com.au)

<sup>4</sup> Justin Leonard, Ecosystem Sciences, CSIRO. Email: [Justin.Leonard@csiro.au](mailto:Justin.Leonard@csiro.au)

## 1. INTRODUCTION

The Black Saturday Bushfires in Victoria in 2009 caused great personal loss and property damage including the deaths of 173 people and the destruction of over 2,000 houses. This raised the question of how houses can be constructed in a robust, economical manner that will improve the chances of survival for people and buildings in bushfires. It was postulated that a conventional steel roof together with steel trusses, steel wall studs with steel external cladding and exposed steel sub floor should be able to survive in the flame zone of a real bushfire, provided due consideration was given to the expected thermal actions and their progressive effects on specific building elements and systems. If this could be shown to be the case, then such construction could also be considered to improve the resistance to bushfire for the majority of situations where direct flame impact may not occur.

Non-combustible construction offered potential benefits which were deemed worthwhile investigating as the building could be configured so that failure of one element did not necessarily lead to failure of the structure. These concepts were fire tested with a full size building [1,2] complemented by smaller scale testing of elements [3,4] by CSIRO using a thermal action curve which conservatively modelled a bushfire [5]. The research was coordinated by the National Association of Steel-Framed Housing (NASH) which has a longstanding commitment to research based building solutions in residential and low-rise construction using familiar, readily available and easily installed products and materials.

To progress this concept, NASH devised a project with the following aims:

- Design a low-rise predominantly non-combustible steel test building utilising a wide variety of common building materials and methods;
- Assess the performance of such a building system against National Construction Code (NCC) [6] Performance Requirements using full scale testing; and
- Provide supporting evidence for Building Authority approval as an Alternative Solution under the NCC Performance Requirement.

In the first phase of this project, NASH engaged the CSIRO to develop a thermal action profile for bushfire exposure, and to conduct a full scale fire test using the Bushfire Flame Front Simulator at the NSW Rural Fire Service Eurobodalla Training Centre near Mogo, NSW. [1,2] This centre is the only facility in the world that can model the immersion of a full scale vehicle or structure in a high intensity bushfire flame front turnover. (See Photograph 1)



**Photograph 1:** Full scale bushfire test

The full scale test proved highly successful in confirming the concept of utilising non-combustible floor, wall and roof systems to provide a robust barrier to protect the habitable space from flame zone conditions. However it also highlighted changes that could be made to improve the performance of the wall system using techniques that did not involve specialised or expensive products, materials or methods. As a result, four improved wall systems were developed for testing using the Radiant Panel Test Facility at CSIRO Ecosystems Science at Highett, Victoria. [3,4]. An advantage in using this facility is that it allowed the wall systems to be exposed to the same radiant heat and flame contact profile that was used for the full scale test. (See Photograph 2)



**Photograph 2:** Small scale wall test

## 2. PERFORMANCE REQUIREMENTS

The National Construction Code (NCC) [6] is a performance based Code with Performance Requirements and Deemed-to-Satisfy solutions. Performance requirements are the only mandatory provisions of the NCC. Being a performance based code, the NCC encourages the development of innovative cost effective alternative solutions. An alternative solution to the deemed-to-satisfy solutions must meet the performance requirements or be shown to be at least equivalent to a deemed-to-satisfy solution. This is also the case for any building solutions described in other proposed design standards.

Resistance to building ignition from bushfires is a requirement of Volumes 1 and 2 of the NCC (Volume 1 GP5.1 and Volume 2 P2.3.4) for buildings constructed in designated bushfire prone areas. Currently AS 3959 [7] is the only deemed-to-satisfy solution for Class 1, 2, 3 and 10a buildings. AS 3959 contains both a Bushfire Attack Level (BAL) assessment methodology as well as construction solutions for each BAL.

The performance requirement for bushfire areas for Class 1 buildings (detached house, row house, terrace house, town house or villa unit) and Class 10a (private garage, carport or shed) in NCC Volume 2 is as follows:

‘A Class 1 building or a Class 10a building or deck associated with a Class 1 building that is constructed in a designated bushfire prone area must, to the degree necessary, be designed and constructed to reduce the risk of ignition from a bushfire, appropriate to the:

- Potential for ignition caused by burning embers, radiant heat or flame generated by a bushfire; and
- Intensity of the bushfire attack on the building.’

Volume 1 of the NCC has very similar wording for Class 2 (2 or more sole occupancy units) and Class 3 (other residential buildings) and associated class 10a buildings.

New South Wales, Queensland, and Tasmania have slight variations to either or both of these volumes. However the performance intent remains the same. It should be noted that two states, NSW and Queensland, require the resistance to ignition “while the fire front passes” but only for Class 2 and 3 buildings. Tasmania applies the same constraint but only to Class 1 buildings.

The Australia Building Codes Board (ABCB) currently has an ongoing project to progressively quantify the NCC Performance Requirements for a range of design actions. Unfortunately the NCC has not yet quantified the required performance for bushfire actions, so the starting point for the project was to seek expert assistance from the bushfire science team at CSIRO Ecosystem Sciences. For the most meaningful

assessment of the performance of a building system under simulated bushfire conditions, the thermal exposure profile should align as closely as possible with the expected conditions in an actual bushfire. CSIRO was asked to prepare an exposure profile for “worst case” bushfire exposure under Australian conditions. They recommended using the thermal modelling approach used in AS 3959 Appendix B [7].

The CSIRO thermal exposure profile proposed by Leonard [5] consists of three phases:

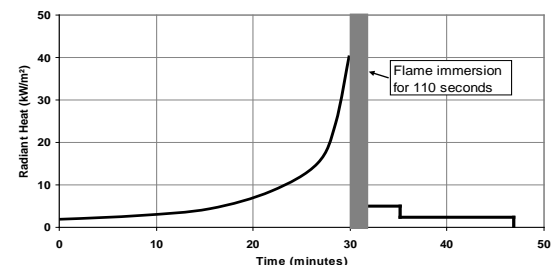
- Pre-radiation,
- flame immersion, and
- post-radiation

The profile is based on a worst case scenario and is similar to the profile recently adopted as the basis for testing of private bushfire shelters. The pre-radiation profile was derived from modelling a range of fire scenarios using various assumptions detailed in methods given in AS 3959 Appendix B. In some cases more conservative assumptions were used; for example:

- The flame body was assumed to have an emissive temperature of 1200°K rather than 1090°K.
- Vegetation setback from the house was zero rather than 10 m.

The flame immersion time was derived from modelling a range of fire scenarios using the detailed method in AS 3959 as well as experimental data from bushfires. A 110 second flame immersion time was determined to be the worst case scenario, although AS 3959 Appendix B does not consider this aspect. The post flame immersion radiant heat profile was based on the burning decay rate from heavy forest fuel fires.

The final recommended profile comprises 47 minutes of radiant heat exposure during which the bushfire flame front approaches, immerses and then recedes from the building. The profile is shown in Figure 1.



**Figure 1:** CSIRO thermal exposure profile

An alternative thermal exposure profile is available as a standard test specification. This test is described in AS 1530.8.2 [8] and was developed in 2007 at the request of Standards Australia Technical Committee FP-020. The committee was seeking a practical test for severe

bushfire exposure that could be conducted using existing laboratory furnaces designed for standard fire tests. The original basis of the bushfire thermal action was similar to the CSIRO profile, but the resulting test regime was modified to reflect the size and thermal characteristics of the available test furnaces. [9]

The key characteristics of the CSIRO exposure profile are:

- The radiant heat and flame exposure is closely representative of an actual bushfire;
- It allows the same exposure profile to be used for full scale and laboratory testing simplifying the comparison and combination of the test results;
- The simulator's flame body closely matches the flame characteristics of a real bushfire in its:
  - Flame temperature which is around 1200°K (actually exceeded during the test);
  - Soot mass fraction giving radiant heat emission similar to bushfire flame fronts;
  - Turbulence & rapid thermal cycling within the flame due to air entrainment and mixing;
  - Heating in an environment where the oxygen in the surrounding air is available to interact with the exposed structure as in real bushfire exposures.

By comparison the 30 minute exposure in AS 1530.8.2, while intentionally severe due to its duration, is performed in a low oxygen furnace having a progressively rising temperature profile with no rapid transitions and approaches a temperature of ~850°C after 30 minutes. The different characteristics of the two tests may create issues for:

- Materials that fail or slump in the 850°C to 1000°C range, or are susceptible to thermal shock, such as glass including some fire rated glazing systems;
- Flammable materials that may be modified by a reduced oxygen environment and not behave as they may in a bushfire exposure. [2]

Since forest fuels can only burn once per bushfire event, it is clear from the work done by CSIRO in developing the thermal exposure profile that the magnitude and duration of radiant heat and flame attack in a real bushfire have physical limits. These limits have been used to construct the thermal exposure profile described above which has been applied in conjunction with suitable testing facilities. In the next section, the development of a design strategy to resist the bushfire attack is discussed.

In a regulatory context, the CSIRO thermal exposure profile can be considered as a proposal for the quantification of the performance requirement for the radiant heat and flame component of bushfire attack. It is based on "worst case" modelling and is therefore well above the 90-95<sup>th</sup> percentile band of peak values that the NCC uses to define structural actions such as imposed, wind and earthquake. The second component

of bushfire attack is the ember action, quantified by the size and travel distance of the embers.

The strategy to address the two quantified actions is to conduct full scale testing to assess radiant heat and flame resistance, and to provide only incombustible spaces for the embers to reach.

### 3. DESIGN STRATEGY

Customary protection from bushfire attack, as typified by AS 3959, involves using specified materials and precise gap control on the exterior envelope of the building. It relies on the ongoing integrity of the building envelope to protect all materials that lie behind it, with the facade expected to simultaneously resist all bushfire exposure conditions and environmental actions. Additionally, the ignition resistant properties of the building envelope rely in some cases on thresholds of combustibility and residual heat release. With this approach, one failure, overload or breach of the building envelope can lead to ignition of any underlying combustible construction elements.

An alternative approach is to consider the habitable space defined by the interior linings and to construct all elements outside this space from heat and ignition resistant materials. A combination of non-combustible facade and cavity construction enables the building to be configured so that failure or damage to one element does not lead to an inevitable failure of the structure or a breach of the habitable envelope. This approach to robust design also means that the building's performance is not highly dependent on the detailing, workmanship and maintenance of the external facade to prevent ignition of combustible elements within roof, wall and subfloor cavities. By considering the entire built system and incorporating inherently non-combustible materials, robust and cost effective building solutions can be achieved. This project has enabled this step to be undertaken effectively.

It is quite difficult to make feature by feature comparison between the AS 3959 facade element approach and the systems approach. They represent different philosophies of design, each responding to the same performance requirements.

The design principles adopted for this project and around which the standard is based can be summarised as follows:

- Non-combustible envelope, structure and insulation materials
- Standard exterior fit and workmanship
- Specific low cost heat barriers where required for thermal control
- Habitable space continuity and integrity
- Door and window elements designed using existing rating system and conformity assessment.

## 4. NASH BUSHFIRE STANDARD

Following the successful development of the system, the challenge was to develop tools to assist in the design and construction of buildings. It was decided that the development of a standard was the best method to allow the information be transferred to practitioners.

The new NASH Standard for Steel Framed Construction in Bushfire Areas [10] provides construction solutions meeting the performance requirements of the National Construction Code for residential and low-rise steel framed buildings in bushfire prone areas. The solutions are based on a systems approach using:

- Materials and construction to resist radiant heat and flame contact based on the tested construction details and specifications; and
- Non-combustible construction to the roofspace, wall system and floor system to eliminate risk of ignition caused by embers.
- Additional details such as brick veneer construction based on expert advice and customary construction practice.

The solutions in the standard cover all aspects of the external building structure including:

- General requirements
- Roof systems with steel roof cladding
- Wall systems including steel, brick veneer and other claddings
- Floor and subfloor systems
- Verandahs and decks

Publication and NCC referencing of the standard will offer benefits including cost savings, simple detailing, robust solutions and redundancy to owners, builders, building designers, architects, building surveyors, developers and engineers involved in the design and construction of residential and low-rise buildings.

The new standard will enable more bushfire resistant homes to be constructed at lower cost in even the most severe bushfire exposure locations, and will reduce the cost of post bushfire repair.

To provide a common base for assessment of the radiant heat component of the thermal action to which the building is exposed, the standard adopts the Bushfire Attack Levels (BAL) of AS 3959. This system comprises five incremental levels designated by the threshold radiant heat flux in kilowatts per square metre experienced by a building element exposed to the bushfire at that level. The levels are BAL-12.5, BAL-19, BAL-29, BAL-40 and BAL-FZ. The fifth level of BAL-FZ or “Flame Zone” involves direct flame contact with the building.

The new standard provides the following solutions for:

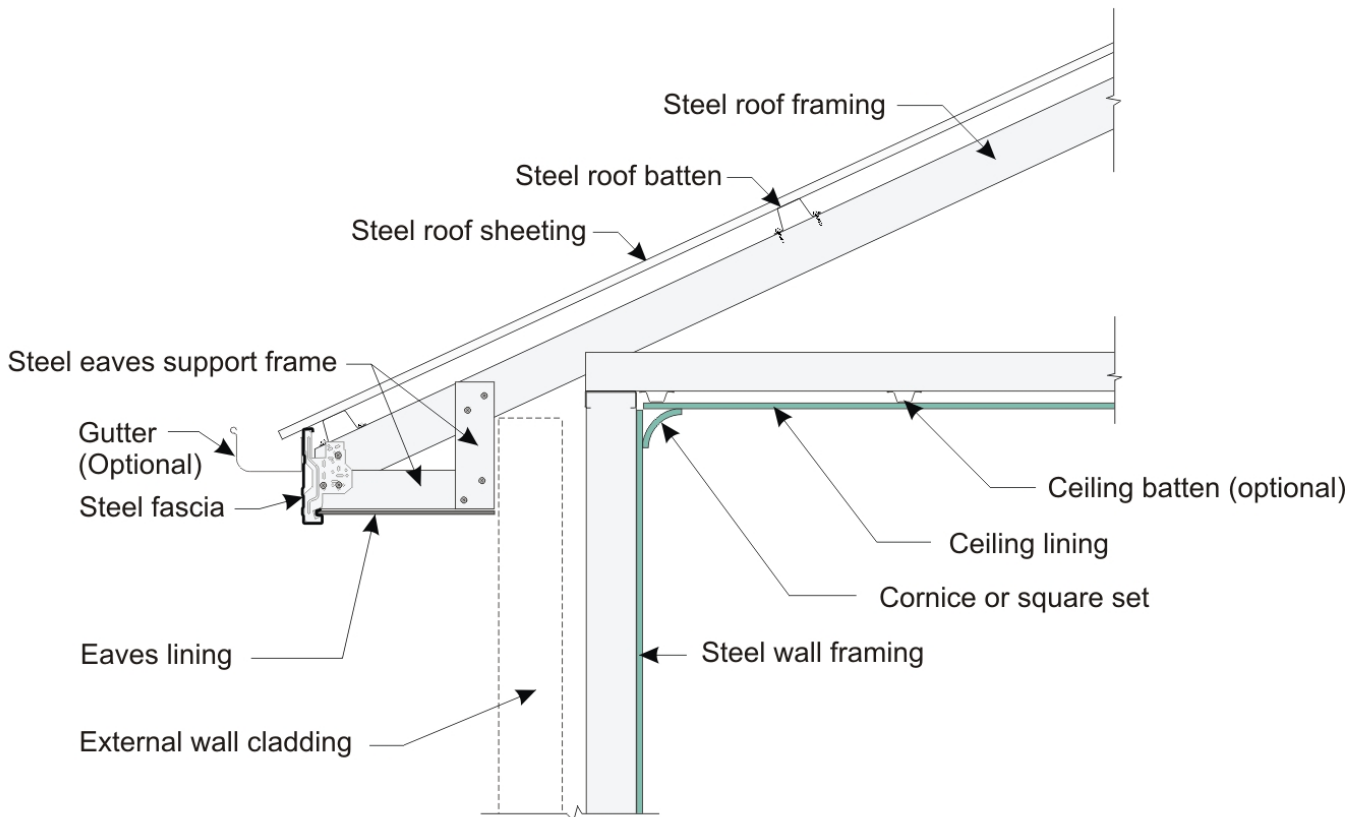
- BAL-12.5 to BAL-40 – standard steel framed construction excluding combustible material from roof and wall cavities.
- BAL-FZ – standard steel framed construction with sarking and glasswool insulation to roof, thermal barrier to walls and provision of non-combustible barrier and insulation to floor beams and joists in open subfloors.

Examples of typical designs for the following building elements are given below:

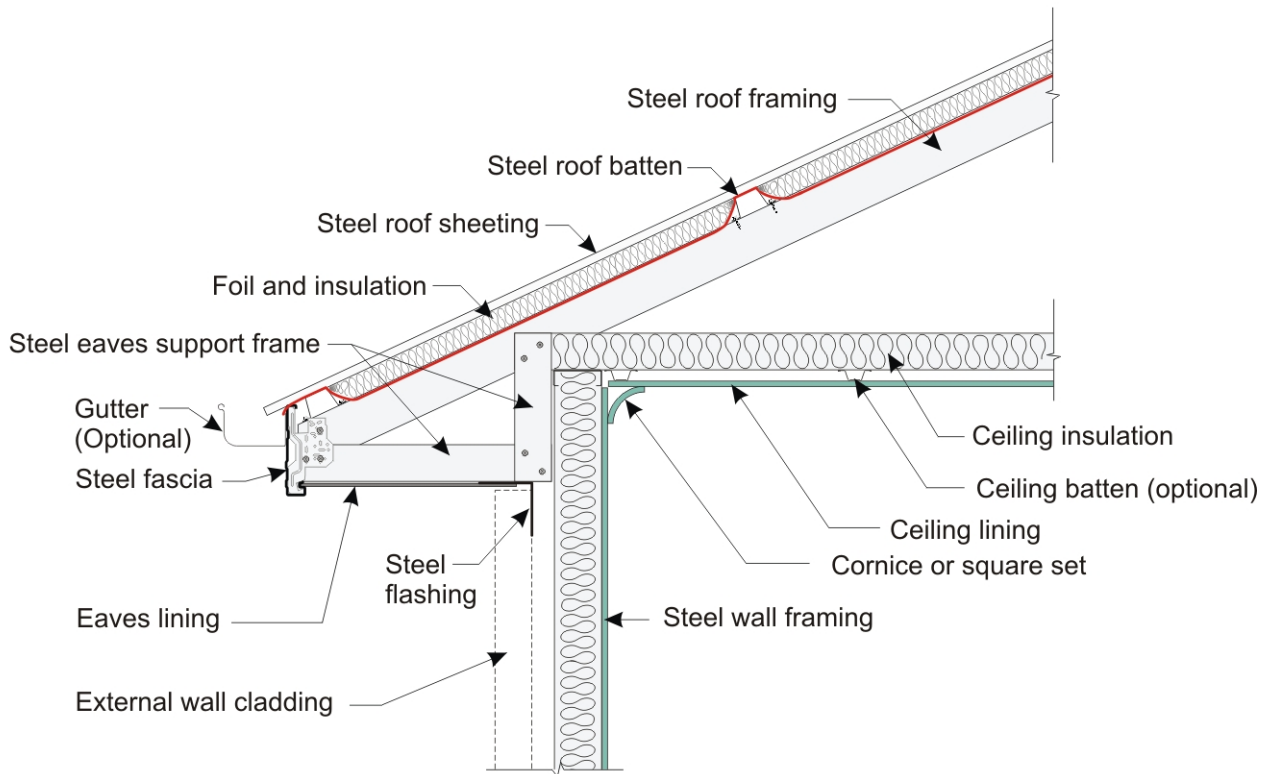
- Roof details – Figures 2 and 3
- Wall details – Figures 4, 5 and 8
- Floor and subfloor details – Figures 6 and 7

There is an ongoing debate on whether any houses should be constructed in BAL-FZ areas. However the NCC and planning regulations allow this in some situations, subject in some cases to additional controls. By providing a solution in the form of a standard, it allows the owner to make a judgement as to whether they wish to provide a more robust solution for their home and allows them to work out the cost and compare it to the benefits. Generally the building envelope, excluding the windows, can be upgraded at a very low cost. The big additional cost item is for windows and to lesser extent external doors.

The standard covers the requirements for bushfires. However additional insulation may be required to achieve the thermal rating required by the NCC. This additional insulation must be glass or mineral wool.

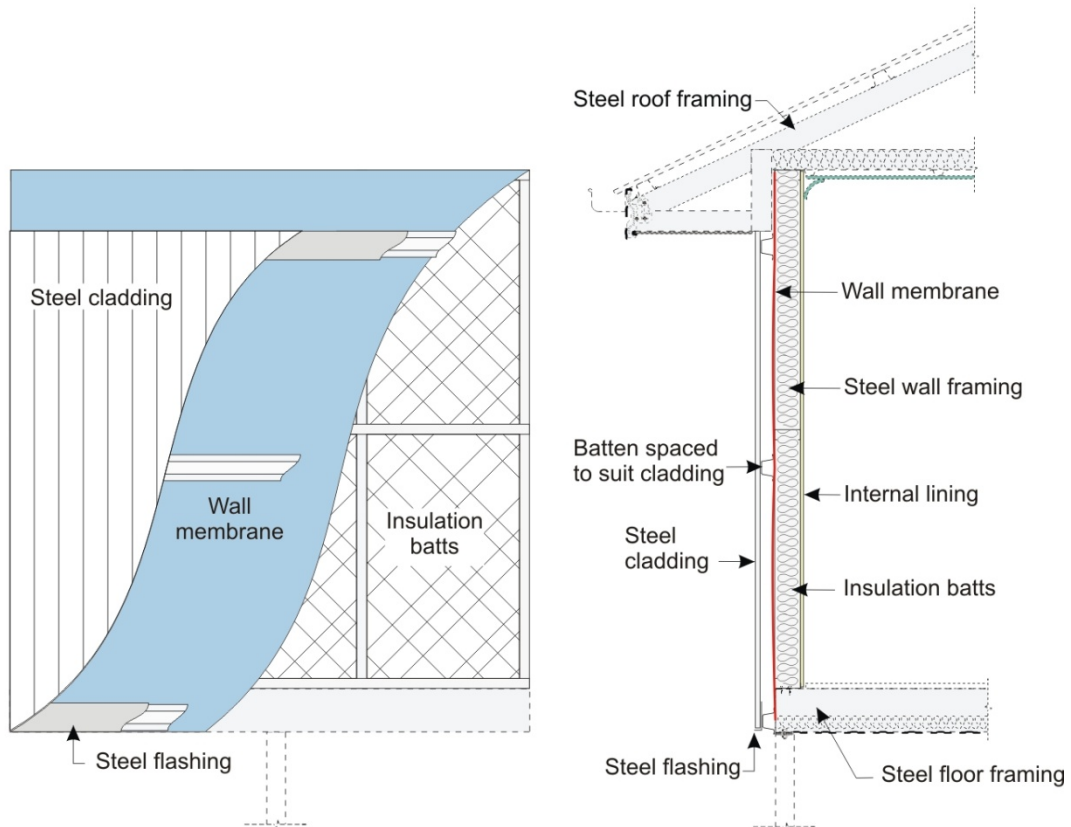


**Figure 2:** Typical steel roof details BAL-12.5, BAL-19, BAL-29 and BAL-40

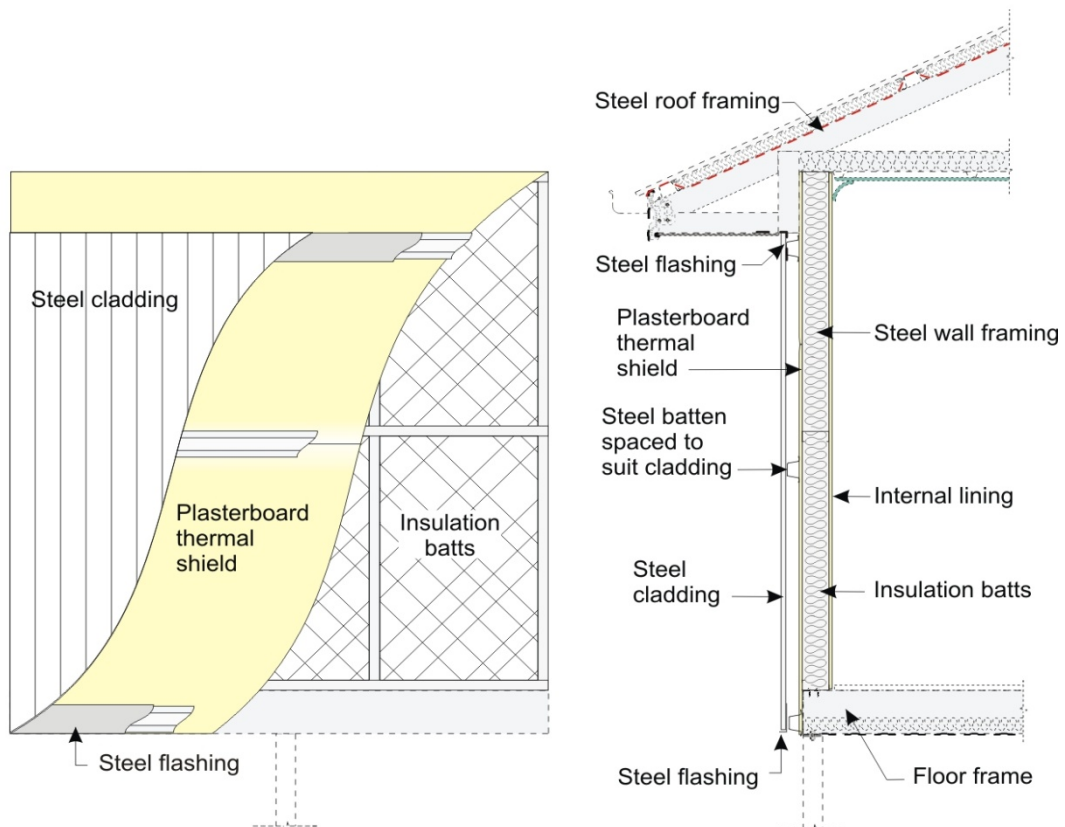


**Figure 3:** Typical steel roof details BAL-FZ

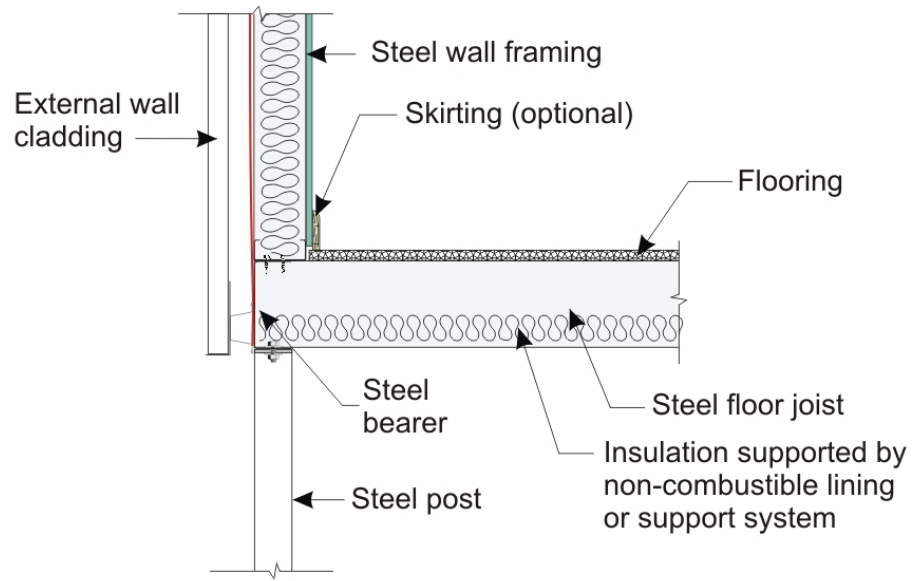




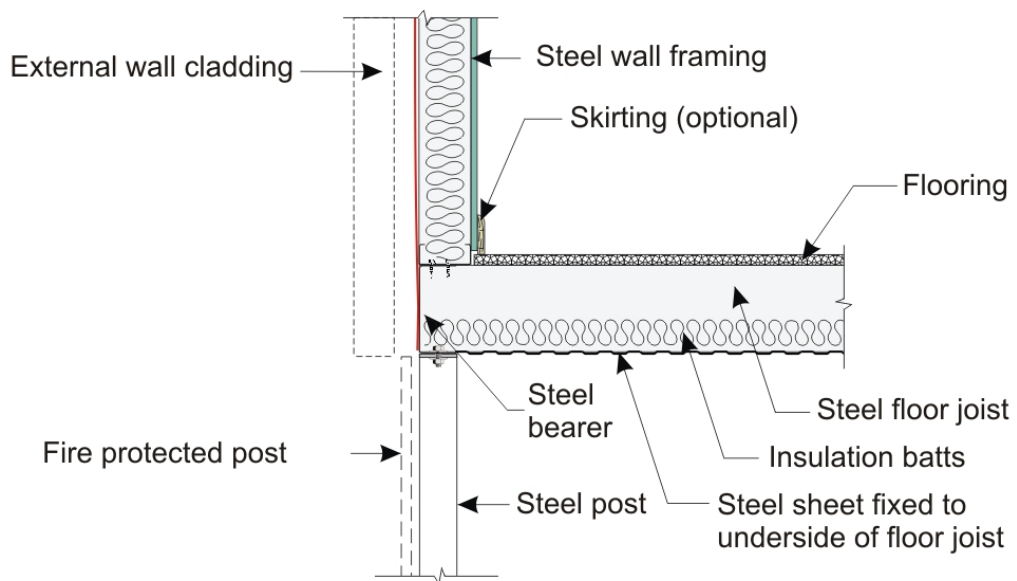
**Figure 4:** Typical steel clad wall details BAL-12.5, BAL-19, BAL-29 and BAL-40



**Figure 5:** Typical steel clad wall details BAL-FZ



**Figure 6:** Typical floor and subfloor details BAL-12.5, BAL-19, BAL-29 and BAL-40



**Figure 7:** Typical floor and subfloor details BAL-FZ



## 5. CASE STUDY

A housing development in Brisbane was used to “road test” the evolving standard (see photographs 3 and 4). Comprising 76 two storey townhouses adjoining an area of classified vegetation, the development required a minimum level of ember protection to all units plus a higher level of resistance to several units directly adjoining the vegetation. The principles of the new standard were applied as an Alternative Solution to improve the bushfire resistance and significantly reduce the construction cost of the project. The expected radiation level to which the dwellings would be exposed was determined as being from BAL-12.5 to BAL-40 depending on the particular dwelling’s location on the site.

The form of construction adopted for the townhouses was a steel roof with brick veneer walls constructed on a concrete slab as shown in photograph 3. Generally the development consists of series of double units, as shown in photograph 4, with the units separated by a fire rated plaster board system on the common wall line in accordance with the requirements of the National Construction Code.

The details of this Alternative Solution are:

- All structural members including beams, trusses and battens are made from steel.
- Ceiling linings are plasterboard.
- Timber or other combustibles are not permitted within the ceiling space even for the support of cladding such as plasterboard.
- No storage of goods within the ceiling space. This was achieved by installing a sign next to any ceiling access hatch stating “Goods are not to be stored within the ceiling space”.
- Any openings into the ceiling cavity between the ceiling and the inside habitable spaces greater than 3 mm are protected with a mesh having a maximum aperture of 2 mm, made from corrosion resistant steel, bronze or aluminium.
- Any service pipes within the ceiling space must be non-combustible or lagged with non-combustible insulation. (Electrical wiring is exempt from this requirement.)
- Any insulation used within the roof cavity must be glass or mineral wool.
- The design solution does not require the use of sarking. However, if sarking is incorporated it must have a flammability index of not more than 5.
- Steel framed brick veneer walls in accordance with Figure 8.



**Photograph 3:** Townhouses under construction

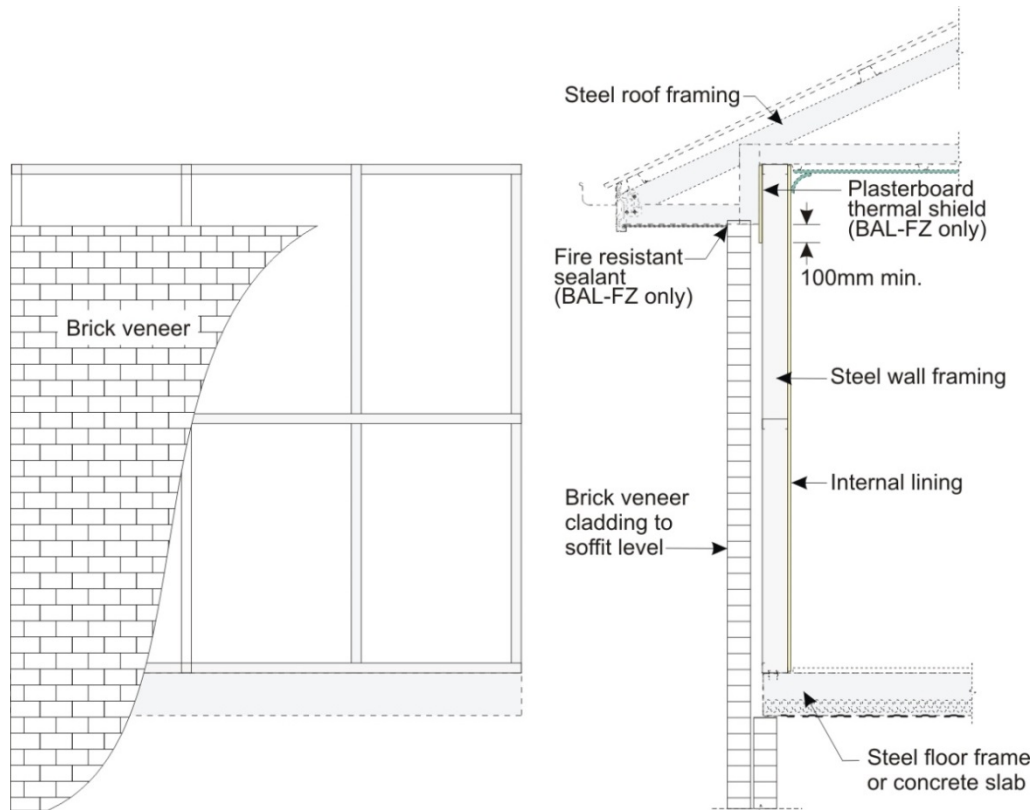


**Photograph 4:** Completed townhouses

## 6. CONCLUSIONS

A research programme into the performance of steel framed houses under bushfire attack has led to the development of a Standard for the economical and robust design of steel framed houses. Experimental research included full scale testing of a house under simulated bushfire attack together with smaller scale tests. The results of these tests were supplemented by fire engineering design.

The result of this work is a simple and easy to use standard that will enable the design of houses to better resist bushfire attack and meet the Performance Requirements of the National Construction Code.



**Figure 8:** Typical brick veneer wall details for all BALs

## ACKNOWLEDGEMENTS

The authors would like to acknowledge the NASH members who have provided industry support and feedback that has made this work possible.

## REFERENCES

- [1] L. Macindoe, J. Leonard, S. Brown. NASH Steel Framed House Burnover – April 2010 CSIRO Report no. EP11725. CSIRO Ecosystem Science. 2010
- [2] K.B. Watson, J.E. Leonard, I Bennetts, M.H. Kelly, L. Macindoe, & T.G. Clayton. Assessing the bushfire performance of low-rise steel structures using full scale bushfire flame front simulation. *ASEC 2010, Sydney Australia*. 2010
- [3] J. Leonard & L. Macindoe. NASH Steel Framed Wall Tests – August 2011. CSIRO Report No. EP11726 CSIRO Ecosystem Science. 2011
- [4] J.E. Leonard, L. Macindoe, K.B. Watson, I.D. Bennetts, M.H. Kelly, T.G. Clayton & D. Baines. Testing of steel wall systems for bushfire zone areas. *ASEC 2012, Perth Australia*. 2012
- [5] J.E. Leonard. Proposed Testing Methodology for a Whole of House Assessment for Flame Zone (BAL-FZ) Equivalent Performance in AS3959-2009. CSIRO Ecosystem Science. 2010
- [6] National Construction Code, Volumes One and Two. Australian Building Codes Board. Canberra, 2013.
- [7] AS 3959 Construction of buildings in bushfire prone areas. Standards Australia 2009.
- [8] AS 1530.8.2 Tests on elements of construction for buildings exposed to simulated bushfire attack - Large flaming sources. Standards Australia 2007.
- [9] P. England, R. Parker & G. Zillante. Evaluation methods for assessing the resistance of elements of construction to bushfire attack. Fire Safety Engineering – for Buildings & Bushfires. Engineers Australia Society of Fire Safety seminar, Sydney, March 2008.
- [10] NASH Standard for Steel Framed Construction in Bushfire Areas Public Comment Draft. National Association of Steel-Framed Housing 2013