

top view

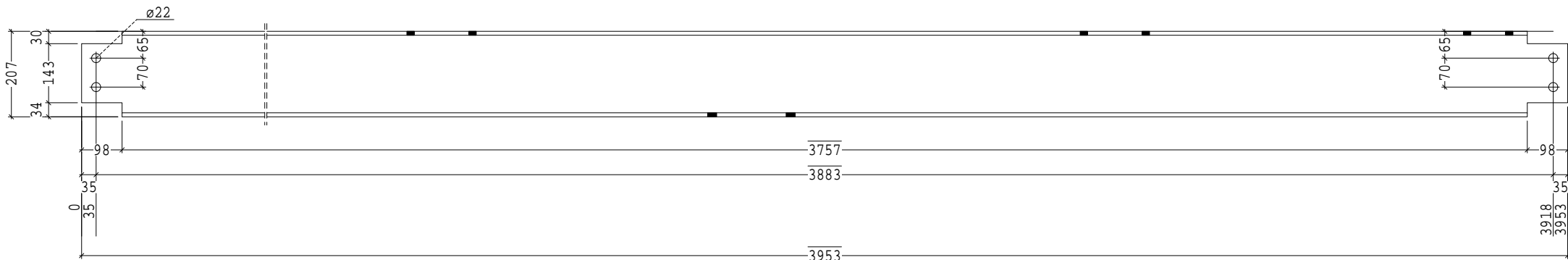

front view

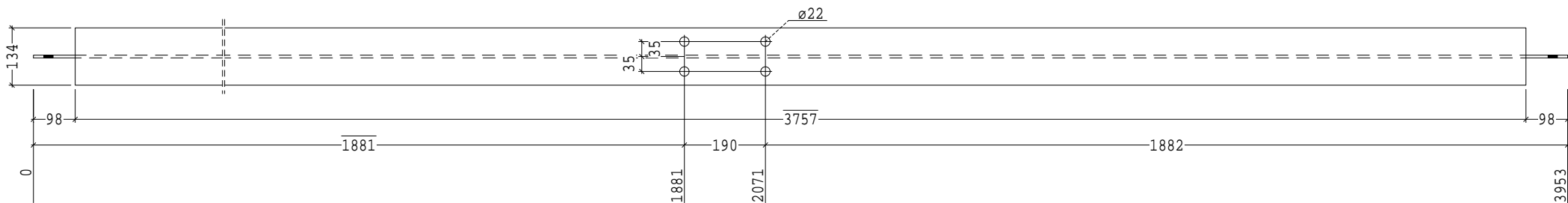

bottom view

Mark	Description	Qty	Profile	Length	Grade	Unit Weight
F_1033	BEAM	1	200UB30	3953	300+	117.79 kg
Main mark locations						
1 * 1 ASSEMBLY A1_313						

REV	DETAILS OF REVISION	NAME	DATE	Variation No.
0	ISSUED FOR APPROVAL & THEN FOR CONSTRUCTION	P.BULAKOVSKI	19.05.2005	XX

GENERAL NOTES
 1. ALL DIMENSIONS ARE IN mm. U.N.O.
 2. FLAME CUT SURFACES TO BE UNIFORM & CLEAN BEFORE WELDING
 3. ALL FILLET WELDS TO BE 6 mm CONTINUOUS U.N.O.
 4. ALL FILLETS TO BE A MINIMUM OF 11 rad. U.N.O.
 5. ALL ASSEMBLIES TO BE CLEARLY MARKED.
 6. ALL MATERIAL TO BE TO A.S. 4100
 7. FOR SURFACE TREATMENT REFER TO PAINT SPECIFICATIONS
 8. ALL WORKMANSHIP & WELDING SHALL BE IN ACCORDANCE WITH AS 4100 & AS 1554 PART 1 CAT. SP FOR F.P.B.W. & CAT. SP FOR FILLET WELDS. ELECTRODES TO B48XX

EDC Client:
LIFESE ENGINEERING
 5 JUNCTION STREET
 AUBURN NSW 2144
 Ph. (02) 9748 0444
 Fax. (02) 9648 3984

DO NOT SCALE PROJECTION

Newcastle Sydney
 Ph. 02 4929 6910 Ph. 02 9251 6786
 Fax. 02 4929 1135 Fax. 02 9251 6787
 mail@edc-drafting.com www.edc-drafting.com

enterprise | drafting | company
 163 King Street Newcastle NSW 2300

THIS DRAWING IS CONFIDENTIAL AND IS THE PROPERTY OF ENTERPRISE DRAFTING COMPANY IT MUST NOT BE DISCLOSED TO A THIRD PARTY EXCEPT BY WRITTEN APPROVAL TO DO SO FROM ENTERPRISE DRAFTING COMPANY

DRAWN P.BULAKOVSKI DATE MAY 2005
 CHKD EDC DATE MAY 2005
 REFERENCE DRAWINGS AS ABOVE
 SCALE NTS

CLIENT: LIFESE ENGINEERING
 PROJECT: HARTLEY QUARRY CONVEYOR C3/C6
 TITLE: 1 BEAM REQUIRED MARKED F_1033

CAD FILE No. F01F_1033 DRAWING No. 04121-FITTING-F_1033
 EDC JOB No. 04121 REV. 0



top view

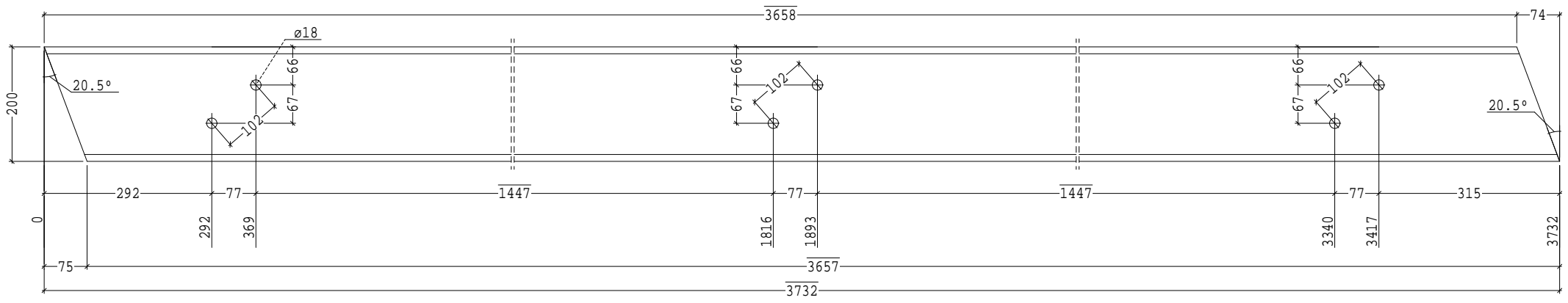

front view

Mark	Description	Qty	Profile	Length	Grade	Unit Weight
F_3047	STAIR	1	200PFC	3732	300+	85.47 kg

Main mark locations
1 * 1 ASSEMBLY A3_404

REV	DETAILS OF REVISION	NAME	DATE	Variation No.
0	ISSUED FOR APPROVAL & THEN FOR CONSTRUCTION	P.DULAKOVSKI	29.06.2005	XX

GENERAL NOTES
 1. ALL DIMENSIONS ARE IN mm. U.N.O.
 2. FLAME CUT SURFACES TO BE UNIFORM & CLEAN BEFORE WELDING
 3. ALL FILLET WELDS TO BE 6 mm CONTINUOUS U.N.O.
 4. ALL FILLETS TO BE A MINIMUM OF 11 rad. U.N.O.
 5. ALL ASSEMBLIES TO BE CLEARLY MARKED.
 6. ALL MATERIAL TO BE TO A.S. 4100
 7. FOR SURFACE TREATMENT REFER TO PAINT SPECIFICATIONS
 8. ALL WORKMANSHIP & WELDING SHALL BE IN ACCORDANCE WITH AS 4100 & AS 1554 PART 1 CAT. SP FOR P.P.B.W. & CAT. SP FOR FILLET WELDS. ELECTRODES TO BAHX

EDC Client:
LIFESE ENGINEERING
 5 JUNCTION STREET
 AUBURN NSW 2144
 Ph. (02) 9748 0444
 Fax. (02) 9648 3984

DO NOT SCALE PROJECTION

Newcastle Sydney
 Ph. 02 4929 6910 Ph. 02 9251 6786
 Fax. 02 4929 1135 Fax. 02 9251 6787
 mail@edc-drafting.com www.edc-drafting.com

enterprise | drafting | company
 163 King Street Newcastle NSW 2300

THIS DRAWING IS CONFIDENTIAL AND IS THE PROPERTY OF ENTERPRISE DRAFTING COMPANY. IT MUST NOT BE DISCLOSED TO A THIRD PARTY PART COPIED AND/OR LENT WITHOUT PRIOR WRITTEN APPROVAL TO DO SO FROM ENTERPRISE DRAFTING COMPANY

DRAWN	DATE
M.BAJOREK	JUNE 2005
CHKD	DATE
EDC	JUNE 2005

REFERENCE DRAWINGS
AS ABOVE

SCALE
NTS

CLIENT: LIFESE ENGINEERING
 PROJECT: HARTLEY QUARRY CONVEYOR C1
 TITLE: 1 STAIR REQUIRED MARKED F_3047

CAD FILE No.	F03F_3047	DRAWING No.	04121-FITTING-F_3047	REV.	0
EDC JOB No.	04121				

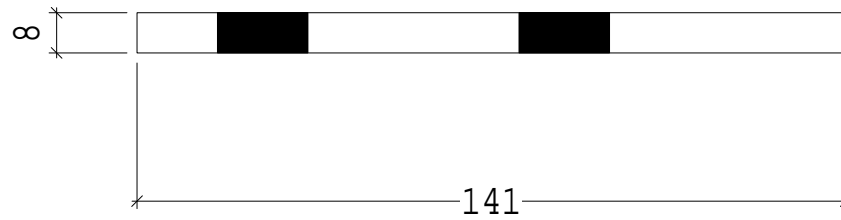

top view

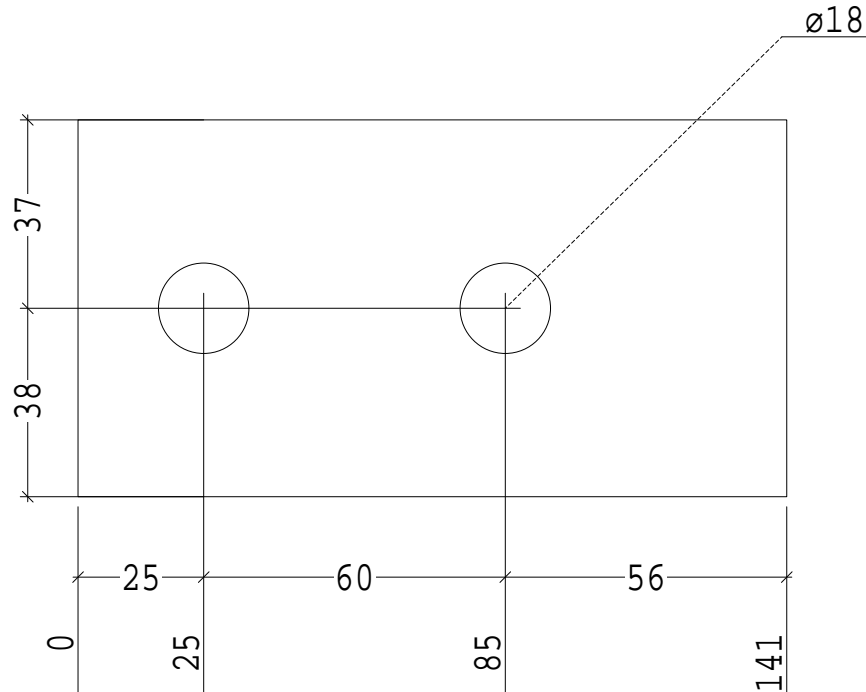

front view

Mark	Description	Qty	Profile	Length	Grade	Unit Weight
F_8175	CLEAT	123	FL8*75	141	250	0.66 kg
Main mark locations						
5 * 1 ASSEMBLY A8_204	5 * 1 ASSEMBLY A8_205	8 * 1 ASSEMBLY A8_302	8 * 1 ASSEMBLY A8_303	7 * 1 ASSEMBLY A8_304		
5 * 1 ASSEMBLY A8_306	11 * 1 ASSEMBLY A8_308	11 * 1 ASSEMBLY A8_309	11 * 3 ASSEMBLY A8_310	11 * 1 ASSEMBLY A8_311		
11 * 1 ASSEMBLY A8_312	8 * 1 ASSEMBLY A8_314					

REV	DETAILS OF REVISION	NAME	DATE	Variation No.
0	ISSUED FOR APPROVAL & THEN FOR CONSTRUCTION	R.VELOVSKI	12.04.2005	TBA

GENERAL NOTES
 1. ALL DIMENSIONS ARE IN mm. U.N.O.
 2. FLAME CUT SURFACES TO BE UNIFORM & CLEAN BEFORE WELDING
 3. ALL FILLET WELDS TO BE 6 mm CONTINUOUS U.N.O.
 4. ALL FILLETS TO BE A MINIMUM OF 11 rad. U.N.O.
 5. ALL ASSEMBLIES TO BE CLEARLY MARKED.
 6. ALL MATERIAL TO BE TO A.S. 4100
 7. FOR SURFACE TREATMENT REFER TO PAINT SPECIFICATIONS
 8. ALL WORKMANSHIP & WELDING SHALL BE IN ACCORDANCE WITH AS 4100 & AS 1554 PART 1 CAT. SP FOR F.P.B.W. & CAT. SP FOR FILLET WELDS. ELECTRODES TO B48XX

EDC Client:
BOWELD CONSTRUCTION PTY. LTD.
 250 BOLONG ROAD, BOMADERRY NSW 2541
 PH. 44 216 781 Fax. 44 221 792

DO NOT SCALE PROJECTION

Newcastle Sydney
 Ph. 02 4929 6910 Ph. 02 9251 6786
 Fax. 02 4929 1135 Fax. 02 9251 6787
 mail@edc-drafting.com www.edc-drafting.com

enterprise | drafting | company
 163 King Street Newcastle NSW 2300

THIS DRAWING IS CONFIDENTIAL AND IS THE PROPERTY OF ENTERPRISE DRAFTING COMPANY IT MUST NOT BE DISCLOSED TO A THIRD PARTY PART COPIED AND/OR LENT WITHOUT PRIOR WRITTEN APPROVAL TO DO SO FROM ENTERPRISE DRAFTING COMPANY

DRAWN N.BOZINOSKI DATE APR.2005
 CHKD DATE
 EDC APR.2005

REFERENCE DRAWINGS
 AS ABOVE

SCALE NTS

CLIENT: BOWELD CONSTRUCTIONS PTY LIMITED
 PROJECT: PENRITH PLAZA - PLANTROOM B
 TITLE: 123 CLEAT REQUIRED MARKED F_8175

CAD FILE No. F08F_8175 DRAWING No. 04100-FITTING-F_8175
 EDC JOB No. 04100 REV. 0



top view

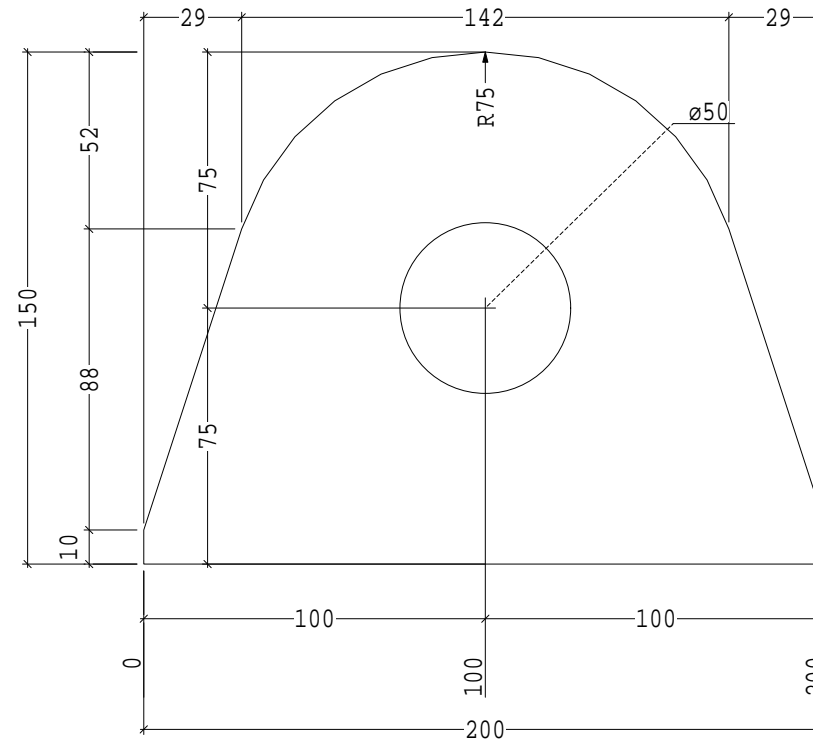

front view

Mark	Description	Qty	Profile	Length	Grade	Unit Weight
F_4425	PLATE	2	PL32*150	200	250	7.54 kg

Main mark locations

2 * 1 ASSEMBLY A4_302

REV	DETAILS OF REVISION	NAME	DATE	Variation No.
0	ISSUED FOR APPROVAL & THEN FOR CONSTRUCTION	M. BAJOREK	02.08.2005	XX

- GENERAL NOTES
- ALL DIMENSIONS ARE IN mm. U.N.O.
 - FLAME CUT SURFACES TO BE UNIFORM & CLEAN BEFORE WELDING
 - ALL FILLET WELDS TO BE 6 mm CONTINUOUS U.N.O.
 - ALL FILLETS TO BE A MINIMUM OF 11 rad. U.N.O.
 - ALL ASSEMBLIES TO BE CLEARLY MARKED.
 - ALL MATERIAL TO BE TO A.S. 4100
 - FOR SURFACE TREATMENT REFER TO PAINT SPECIFICATIONS
 - ALL WORKMANSHIP & WELDING SHALL BE IN ACCORDANCE WITH AS 4100 & AS 1554 PART 1 CAT. SP FOR F.P.B.W. & CAT. SP FOR FILLET WELDS. ELECTRODES TO B48X

EDC Client:
LIFESE ENGINEERING
 5 JUNCTION STREET
 AUBURN NSW 2144
 Ph. (02) 9748 0444
 Fax. (02) 9648 3984

**DO NOT SCALE
 PROJECTION**



Newcastle
 Ph. 02 4929 6910
 Fax. 02 4929 1135
 mail@edcgroup.com.au

Sydney
 Ph. 02 9251 6786
 Fax. 02 9251 6787
 www.edcgroup.com.au

EDC

enterprise | drafting | company
 163 King Street Newcastle NSW 2300

THIS DRAWING IS CONFIDENTIAL AND IS THE PROPERTY OF ENTERPRISE DRAFTING COMPANY IT MUST NOT BE DISCLOSED TO A THIRD PARTY PART COPIED AND/OR LENT WITHOUT PRIOR WRITTEN APPROVAL TO DO SO FROM ENTERPRISE DRAFTING COMPANY

DRAWN	DATE
M. BAJOREK	AUG. 2005
CHKD	DATE
EDC	AUG. 2005
REFERENCE DRAWINGS	
AS ABOVE	
SCALE	NTS

CLIENT:	LIFESE ENGINEERING		
PROJECT:	HARTLEY QUARRY CONVEYOR C2		
TITLE:	2 PLATE required marked F_4425		
CAD FILE No.	F04F_4425	DRAWING No.	04121F04F_4425
EDC JOB No.	04121	REV.	0

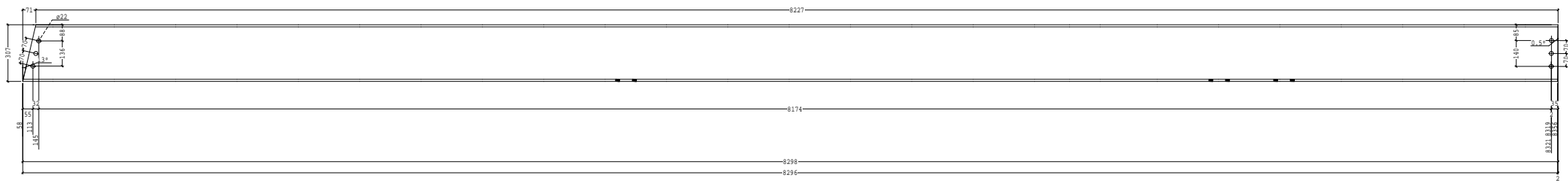

front view unfolded

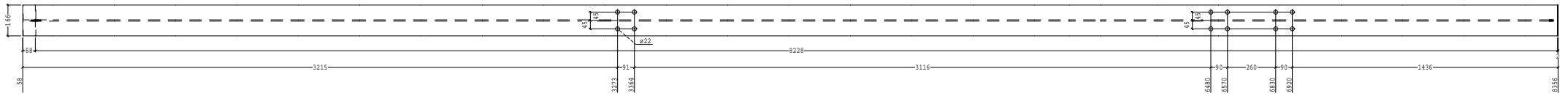

bottom view unfolded

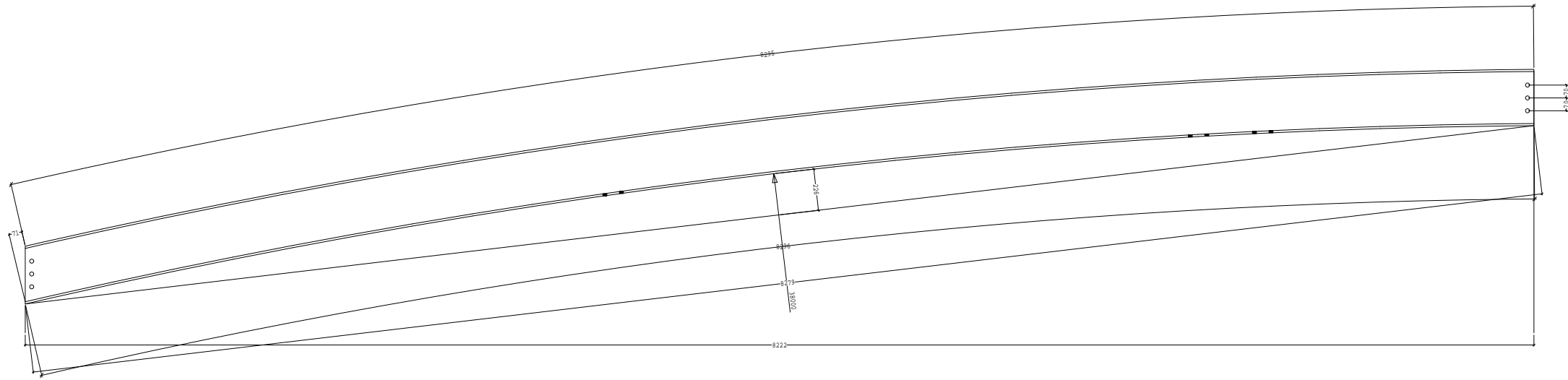

front view

Mark	Description	Qty	Profile	Length	Grade	Unit Weight
F_8003	BEAM	1	310UB46	8298	300+	383.39 kg
Main mark locations						
1 * 1 ASSEMBLY A8_303						

REV	ISSUED FOR APPROVAL & THEN FOR CONSTRUCTION	DETAILS OF REVISION	NAME	DATE	Variation No.
0	ISSUED FOR APPROVAL & THEN FOR CONSTRUCTION		R. VELOVSKI	12.04.2005	TBA

GENERAL NOTES
 1. ALL DIMENSIONS ARE IN mm. U.N.O.
 2. FLAME CUT SURFACES TO BE UNIFORM & CLEAN BEFORE WELDING
 3. ALL FILLET WELDS TO BE 6 mm CONTINUOUS U.N.O.
 4. ALL FILLETS TO BE A MINIMUM OF 11 rad. U.N.O.
 5. ALL ASSEMBLIES TO BE CLEARLY MARKED.
 6. ALL MATERIAL TO BE TO A.S. 4100
 7. FOR SURFACE TREATMENT REFER TO PAINT SPECIFICATIONS
 8. ALL WORKMANSHIP & WELDING SHALL BE IN ACCORDANCE WITH AS 4100 & AS 1554 PART 1 CAT. SP FOR F.P.B.W. & CAT. SP FOR FILLET WELDS. ELECTRODES TO B48XX

EDC Client:
BOWELD CONSTRUCTION PTY. LTD.
 250 BOLONG ROAD, BOMADERRY NSW 2541
 PH. 44 216 781 Fax. 44 221 792

DO NOT SCALE PROJECTION

Newcastle Sydney
 Ph. 02 4929 6910 Ph. 02 9251 6786
 Fax. 02 4929 1135 Fax. 02 9251 6787
 mail@edc-drafting.com www.edc-drafting.com

enterprise | drafting | company
 163 King Street Newcastle NSW 2300

THIS DRAWING IS CONFIDENTIAL AND IS THE PROPERTY OF ENTERPRISE DRAFTING COMPANY IT MUST NOT BE DISCLOSED TO A THIRD PARTY EXCEPT BY WRITTEN APPROVAL TO DO SO FROM ENTERPRISE DRAFTING COMPANY

DRAWN	N. BOZINOSKI	DATE	APR. 2005
CHKD	EDC	DATE	APR. 2005
REFERENCE DRAWINGS			
AS ABOVE			
SCALE	NTS		

CLIENT:	BOWELD CONSTRUCTIONS PTY LIMITED		
PROJECT:	PENRITH PLAZA - PLANTROOM B		
TITLE:	1 BEAM REQUIRED MARKED F_8003		
CAD FILE No.	F08F_8003	DRAWING No.	04100-FITTING-F_8003
EDC JOB No.	04100		0