

# Logistics Safety Guideline

## Mobile Equipment

### 1. About this Guideline...

- This guideline is intended to provide a guide to the safe use of mobile equipment in the workplace. Mobile equipment refers to forklifts, cranes, trucks, trains and cars.
- There may be other risks associated with the use of mobile equipment that are not covered by this guideline, so **TAKE TWO** minutes to stop and think about potential problems **before you start!**

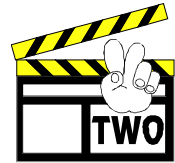

# *M*anage *O*perational *B*ehaviours, *I*nteractions, *L*oading & *E*QUIPMENT

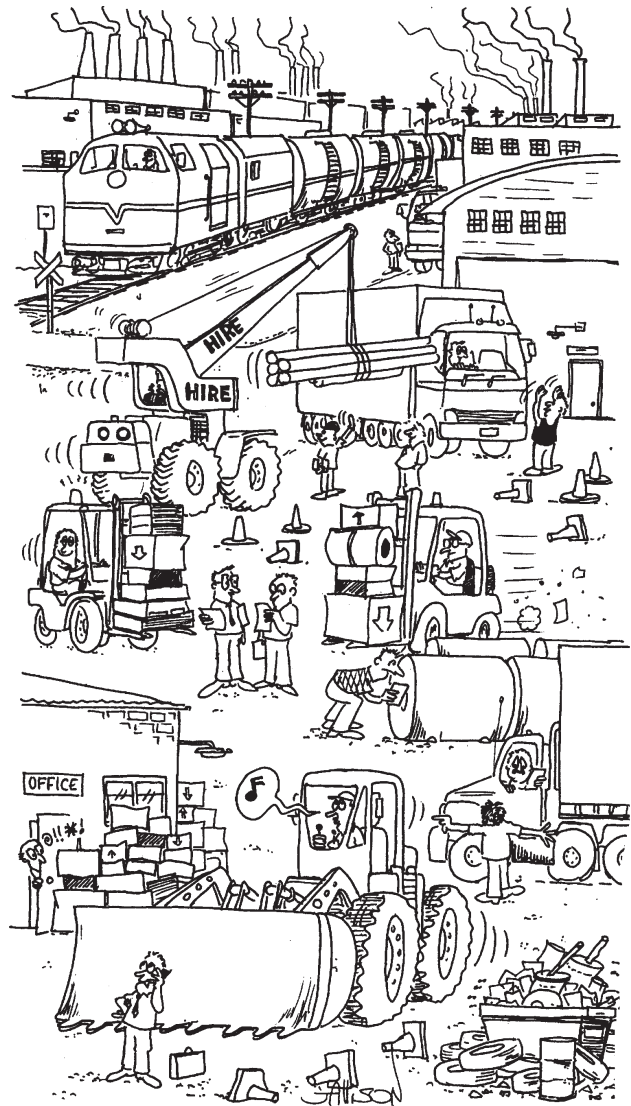

# Logistics Safety Guideline

## Mobile Equipment

### Case Study 1 - Slab Dropped from Straddle, Port Kembla

A slab dropped from a straddle causing significant damage to the machine and a Lost Time Injury to the driver.

The slab was picked up unevenly causing the front set of jaws to be overloaded. During travel the lift chain on one side broke causing the slab to drop to the ground at the leading edge and dig into the bitumen. As a result the straddle came to a hard and sudden stop.

Although wearing his seat belt, the driver was thrown about the cabin straining his neck and back, and required time off work.



#### Key Issues:

- Seatbelts save lives! If the driver was not wearing his seat belt he would have been thrown out the front window and injured more seriously.
- The machine was fitted with a seatbelt interlock to prevent the engine starting until the seatbelt was fastened. These can be fitted to forklifts and other mobile equipment.

## Interactions

All mobile equipment interaction should be controlled through the:

- Establishment of exclusion zones (see page 3).
- Separation of mobile equipment and pedestrians through the use of:
  - ⇒ Barriers;
  - ⇒ Signage;
  - ⇒ Designated walkways;
  - ⇒ Time and space i.e. mobile equipment Hazard Zones (see page 4).
- Traffic management.



### Basic Principles for Developing a Traffic Management Plan

1. Mark all mobile equipment and pedestrian traffic flows on a site plan/map. (Use different colours to distinguish different mobile equipment).
2. Identify “conflict” points i.e. areas where different mobile equipment and/or pedestrians cross paths.
3. Assess the number of times conflict is likely to occur, the more interactions the greater the conflict and the higher the risk.
4. Reduce the number of conflict points and interactions by re-routing traffic flows and/or separating pedestrians and mobile equipment.

Basic example of concept

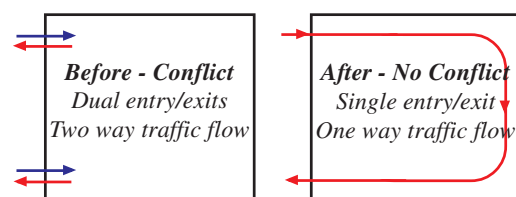

# Logistics Safety Guideline

## Mobile Equipment

### Interactions (continued)

#### Exclusion Zones

- For more details refer to the Logistics Safety Guideline “Loading and Unloading of Trucks”.

**Green Zones:** People can see and be seen and are clear of potential falling product.



**Red “No Go” Zone:** Stay well clear of Forklifts, Cranes and moving loads.

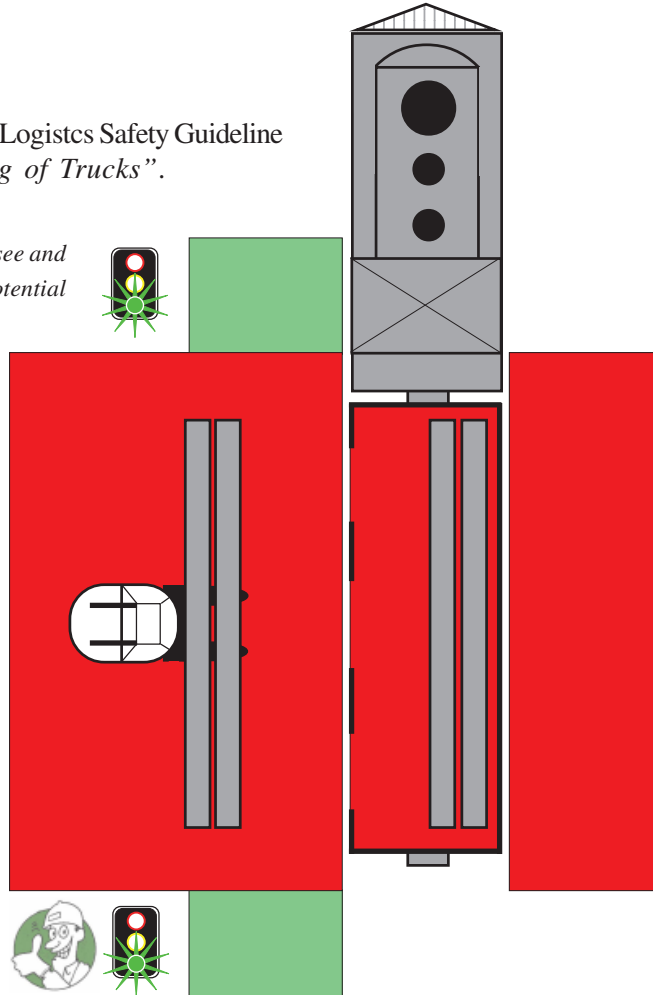

**Red Zone:** Far side from loading is much more dangerous than appreciated.



#### Barriers

- In addition to exclusion zones, it is considered good practice to use physical barriers to separate workers from forklifts, and other mobile equipment, during the loading and unloading process.
- Barriers may be fixed or temporary portable type.

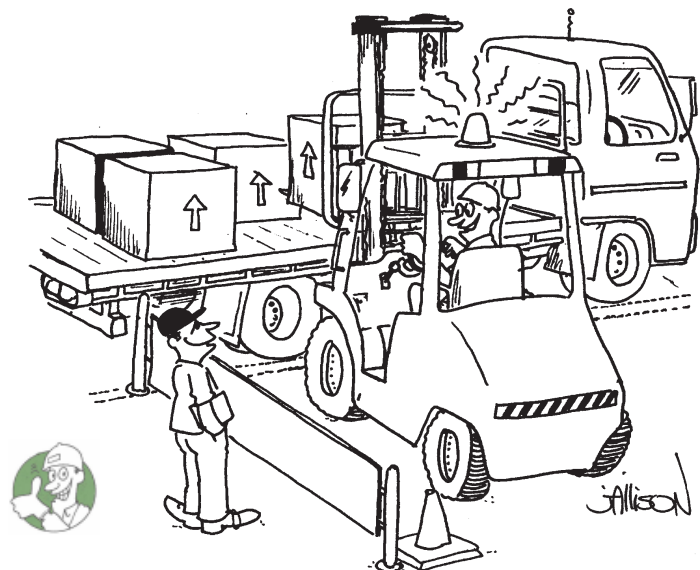

# Logistics Safety Guideline

## Mobile Equipment

# Interactions (continued)

## Hazard Zones

- Where mobile equipment and workers cannot be separated by space, as with conventional exclusion zones, the two should be separated by time. This ensures they are **never in the same place at the same time!**
- When a worker is in the Hazard Zone, mobile equipment is not, and vice versa. It is recommended that all sites adopt Hazard Zones to suit their layout and situation.

**When a worker is in the Zone, no forklift truck or other vehicle may enter!**

**When a forklift truck or other vehicle is operating in the Zone, other vehicles or workers must not enter!**

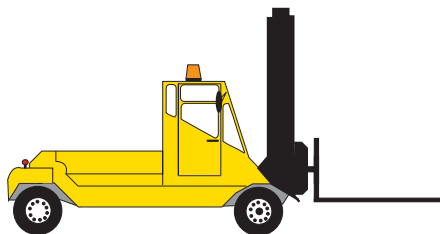

*When mobile equipment is operating in the Zone, other mobile equipment or workers must not enter.*

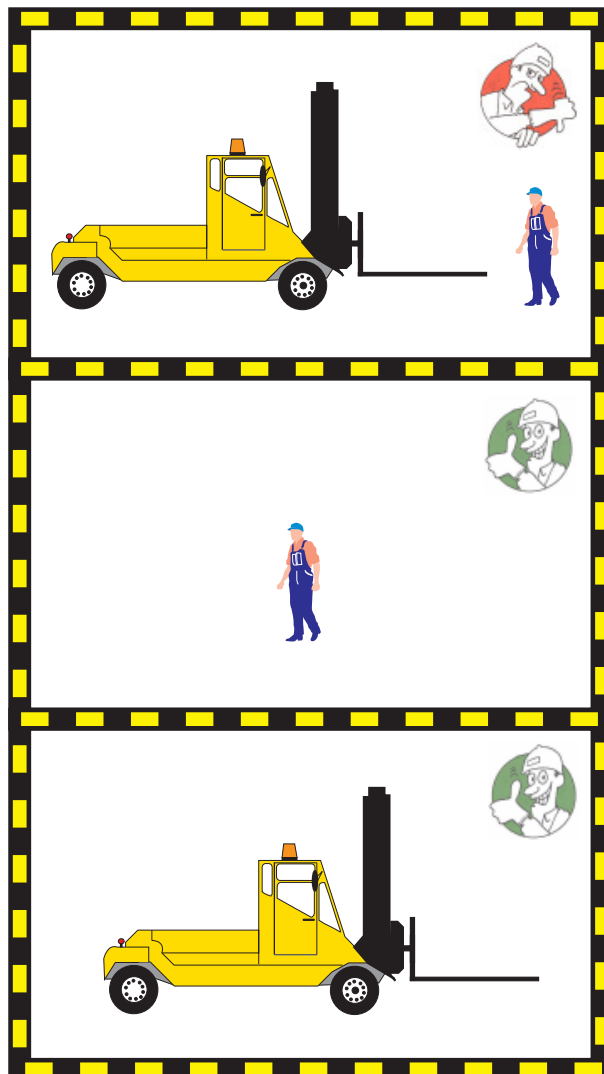

*When a worker is in the Zone, no mobile equipment may enter.*



# Logistics Safety Guideline

## Mobile Equipment

# E

## quipment

All mobile equipment used must:

- Be fit for purpose.
- Meet minimum safety standards e.g. forklifts must meet code of practice.
- Have appropriate safety systems and devices, for example:
  - ⇒ Signage;
  - ⇒ Motion alarms;
  - ⇒ High visibility markings;
  - ⇒ Seat belts;
  - ⇒ Warning lights;
  - ⇒ Driving lights.
- Have a suitable maintenance program to ensure the equipment is safe to operate such as a check list.



*"I suppose this damage was done and not reported by 'some bloke' as well. No, I think it was his brother the 'other bloke'!"*

**All damage to equipment should be reported immediately to the supervisor and be tagged appropriately.**



*Mobile equipment must be fit for the job, meet minimum safety standards, and have appropriate safety systems & devices. Operators should check all of the above prior to using any mobile equipment.*

### Best Practice Hint:



*Consider using additional safety systems to increase the visibility in and around mobile equipment and to reduce worker interactions. Examples include:*

- *Motion detectors and warning alarms (sirens) on mobile equipment and doorways.*
- *Boom gates or physical barriers at doorways and pedestrian crossings.*
- *Replacing cladding at doorways with perspex sheeting or windows to improve lines of sight of both equipment operators and pedestrians.*
- *Closed circuit TV systems on mobile equipment and buildings, etc.*

# Logistics Safety Guideline

## Mobile Equipment

# B

## ehaviours (of Workers)

Operating personnel must:

- Have an appropriate licence or WorkCover ticket to operate the equipment. Note, licences are only a minimum basic entry-level requirement. Operators need to be trained and assessed in new or unfamiliar equipment and/or conditions on an ongoing basis.
- Be trained in site-specific use of the equipment e.g. standard operating procedures (SOP's) and job safety analysis (JSA's).
- Undergo refresher training at minimum every two years.
- Be aware of all hazards associated with site-specific operations.
- Wear the correct PPE as required by the sites' PPE policy.
- Be aware of, and comply to, your companies Drug and Alcohol Policy.
- Undergo regular health checks, in particular eye and ear tests.
- Be aware of, and comply to, companies Mobile Communications Policies.
- Good operator behaviour should be recognised and reinforced.

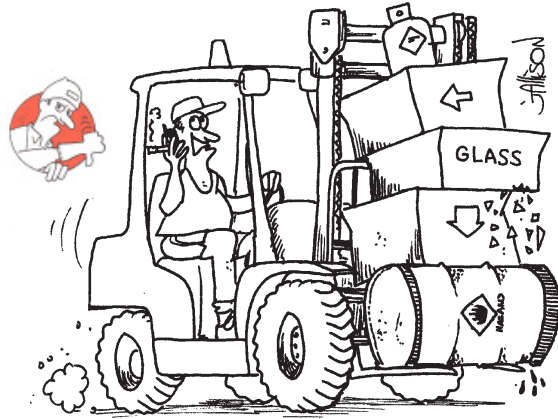

### Case Study 2 - Forklift Fatality in Victoria

A forklift driver was killed in Victoria when the forklift he was driving overturned and crushed him.

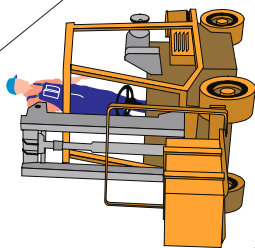

The man was driving the forklift up a slope when it tipped to the side. He jumped from the cabin but was struck by the safety cage and was crushed by it. He was not wearing a seatbelt at the time.

#### Key Issues:

- Seatbelts save lives!
- Employers need to take into consideration the conditions in which forklifts are being operated, and put measures in place to prevent forklifts from tipping over.

Incident courtesy of Victorian WorkCover Authority. Diagram author's interpretation only and not an accurate portrayal of actual events.

# Logistics Safety Guideline

## Mobile Equipment

### **O**perational

When operating mobile equipment the following safe behaviours should be practiced:

1. Prior to using any mobile equipment a pre-start checklist should be performed.
2. Seat belts must be worn at all times while operating equipment.
3. Under no circumstances should mobile phones or music devices be used by operators when equipment is in motion.
4. Equipment must not be overloaded or operated beyond its limits. Load centres should be calculated correctly. Adhere to job and tyre safe working loads.
5. Operators must adhere to the “Can’t See? Can’t Work!” principle.
6. Equipment should be operated to the conditions at hand with the following taken into account (weather, condition of the ground, visibility etc).

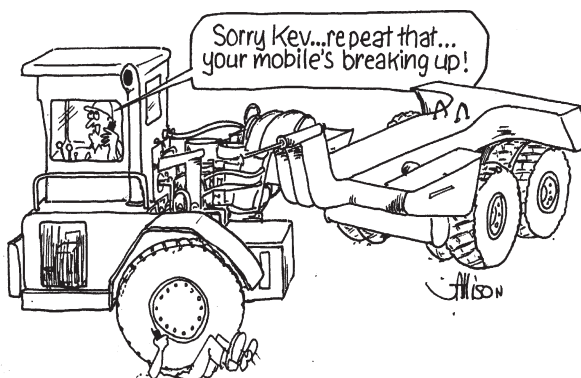

Equipment operators must stop safely prior to using mobile phones or other communication devices. Likewise, pedestrians need to move to a safe place before using these devices. Walking and talking on these devices should not be permitted.

**CAN'T SEE?  
CAN'T WORK!**

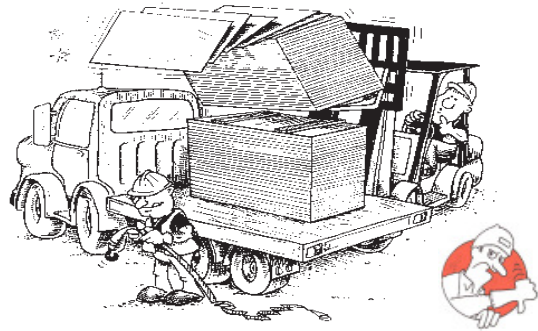

Working without a clear view of others is an unsafe act!

#### A Note on Forklift Lifting Capacities...

- The Safe Working Load (SWL) of a forklift is stated in terms of a load weight and load centre. It is stamped on the load rating plate.
- SWLs must not be exceeded. If the load weight is too great the forklift can tip over.
- As a load is tilted forward or moved further out on the forklift tynes, the centre of gravity moves away from the fulcrum so that the SWL capacity decreases.

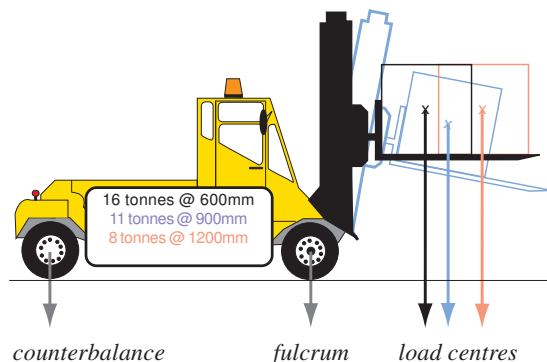

*Example only, depicting effect of load centre on forklift lifting capacity.*

- Forklift operators must know and understand the details of the capacity of the forklift for each different circumstance.
- It is the responsibility of the owner to provide a load plate that displays the lifting capacity of the machine under all lifting conditions. **Do not** use a forklift that does not have a load plate.

# Logistics Safety Guideline

## Mobile Equipment

### Operational (continued)

7. All incidents, near misses or equipment failures/damage should be reported immediately. Environmental hazard controls should be in place.
8. Exclusion Zones and/or Hazard Zones should be adhered to at all times.
9. Machines should never be left running without an operator.
10. Suspended loads should never be left unattended.
11. Keys to equipment should never be left in unattended machines. Keys should also be locked in secure place at end of shift.

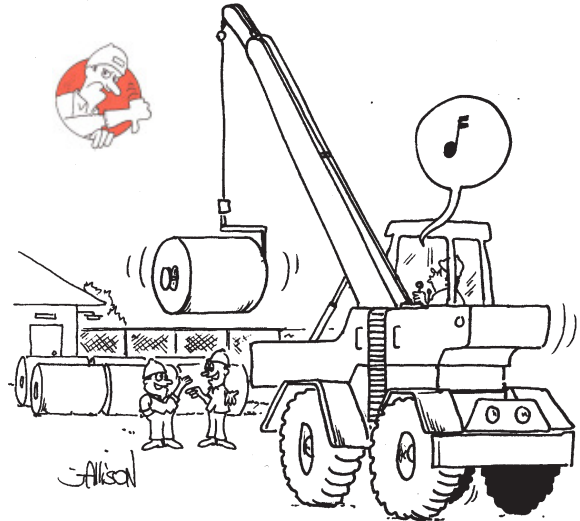

*Pedestrians should NEVER walk under suspended loads. Likewise, operators should NEVER pass over workers with suspended loads.*

#### Case Study 3 - Young Worker Run Over by Forklift in Victoria

*A forklift driver was seriously injured after being run over by the forklift he was driving.*

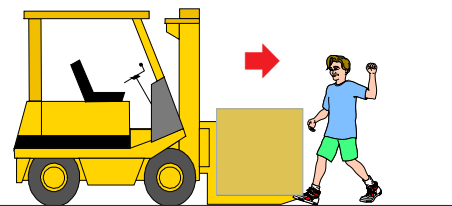

*The forklift driver got off the forklift to adjust the load and was run-over when the forklift moved forward. He sustained a broken leg and injuries to his foot.*

#### Key Issues:

- Ensure the park brake is applied and the forklift is stationary prior to getting on or off.
- Workers and forklifts must be separated.

*Incident courtesy of Victorian WorkCover Authority. Diagram author's interpretation only and not an accurate portrayal of actual events.*

"This material was developed by the Australian Steel Institute as part of a project funded under the WorkCover NSW WorkCover Assist Program. Any views expressed are not necessarily those of WorkCover NSW. This Guideline provides general information only by way of guidance and reliance upon it is voluntary. Compliance with all applicable laws is the user's responsibility as is the need to ensure all methods and procedures used are suitable and adequate for all operating conditions so as to meet this responsibility. The Australian Steel Institute neither makes any representation nor provides any warranty that the information and suggestions in the Guideline are complete or will meet or deal with all circumstances. To the full extent permitted by law the Australian Steel Institute excludes any and all liability to any user or any other person arising out of the use or reliance upon this Guideline."